

THE SYSTEM FOR MEASURING THE BASIC PARAMETERS OF GRINDING TOOLS

Ing. Pavel STRÍTECKÝ, Doctoral Degree Programme (1)
Dept. of Control and Instrumentation, FEEC, BUT
E-mail: xstrit02@stud.feec.vutbr.cz

Supervised by: Dr. Zdeněk Malec

ABSTRACT

In this article, the software for semiautomatic check-out system for the grinding tools is described. The check-out system consists of measuring bench, HBM Spider8 measuring central and PC with control software. The software controls the support movement, data acquisition and analysis and communication with user. It is created in LabVIEW 6.1 [1].

1 INTRODUCTION

A Czech company manufacturing grinding tools asked for creating a check-out system for their manufacturing plant. In cooperation with another company, the hardware realization of the check-out system was designed and constructed. My work was to create the control program for this system.

The primary function of the system is to measure the basic geometric parameters of the grinding tools [2]. The basic shape of the grinding tool is shown in Fig. 1. Measured parameters are height, outer diameter and hole diameter (T , D , H in Fig. 1). All parameters should be measured at least in two points on the side of the tool (e.g.: when the outer diameter is measured, two numbers will be acquired - outer diameter measured in height $h_1 = 0.9 T$ and outer diameter measured in height $h_2 = 0.1 T$).

The secondary function of the system is to compute several additional parameters of the grinding tools, which include axial and radial vibrations, circularity [4], tool body axis and hole axis deviation and parallelity of the fronts of the tool [5]. As a complement, the measuring of weight of the grinding tools is implemented.

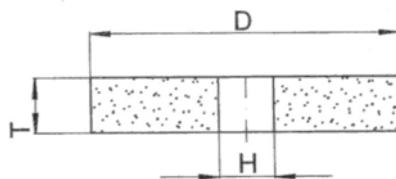

Fig. 1: Grinding tool with marked dimensions, basic shape [2]

2 CHECK-OUT SYSTEM DESCRIPTION

The hardware realization consists of measuring bench, Spider8 measuring central [3] and PC with control program.

The measuring bench contains turning base for grinding tool fixation and xz plane movable support. The turning base has two parts - the upper part is used to center and fix the grinding tool in measuring position, the lower part is vertically movable and holds three weight sensors (tensometric - single point). The support is movable in xz plane and contains one laser length sensor (triangular principle). The length sensor can be positioned vertically - for measuring the height, or horizontally - for measuring the diameters. The bench contains three incremental sensors - two for measuring the support position, one for the angle of the turning base. The picture of the measuring bench is shown in Fig. 2.

The Spider8 measuring central is used as a interface between the bench and the PC. It communicates with PC by IEEE 1248.

The PC holds the control software described in the next chapter.

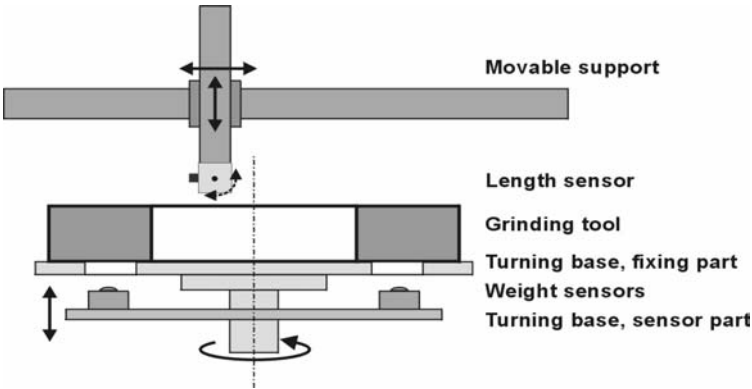

Fig. 2: *The configuration of the check-out system, measuring bench*



Fig. 3: *The picture of the check-out system*

3 PROGRAM DESCRIPTION

The program is created in NI LabVIEW 6.1 [1]. It controls all functions of the system and is divided into five parts. The basic technological data about the grinding tools (needed to verify the computed values) are stored in user-modified database.

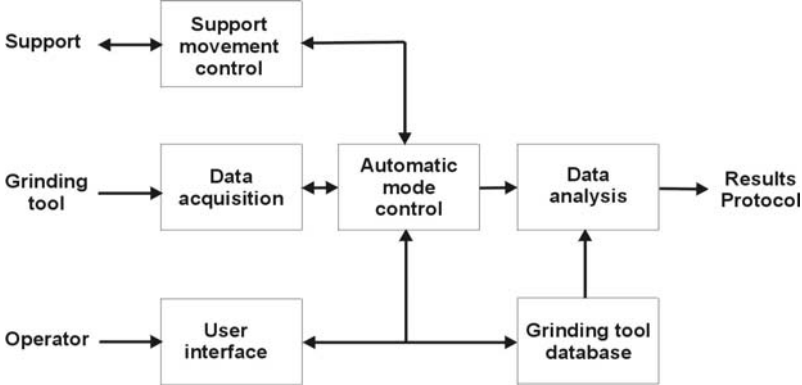

Fig. 4: Program block scheme

3.1 SUPPORT MOVEMENT CONTROL

The support movement control part controls the movement of the support and communication between PC and all sensors and actuators. It maintains the necessary channel switching (some channels are used for measuring more signals). The incremental sensors used for measuring the support position and the angle of the turning base are not absolute, so the program must store their values to ensure proper work and prevent the loss of information when power off.

3.2 DATA ACQUISITION

For data acquisition, there was a specific way developed. Instead of measuring single values in several points uniformly distributed over the area of interest (e.g. upper side of the tool when measuring the height), a whole array of samples is acquired while rotating the tool over 360 degrees. The number of samples in the array depends on the sampling frequency and the rotation speed. The rotation of the tool is performed by the operator, so the array must be passed through the preprocessing block to achieve required length and distribution.

For each basic parameter (T, D, H), two arrays are acquired (Fig. 5) - it means six arrays (six rotations of the tool) for all parameters. These arrays are stored in the file in PC for analysis.

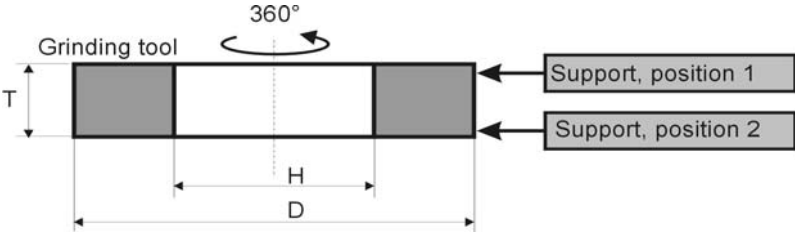

Fig. 5: The principle of data acquisition

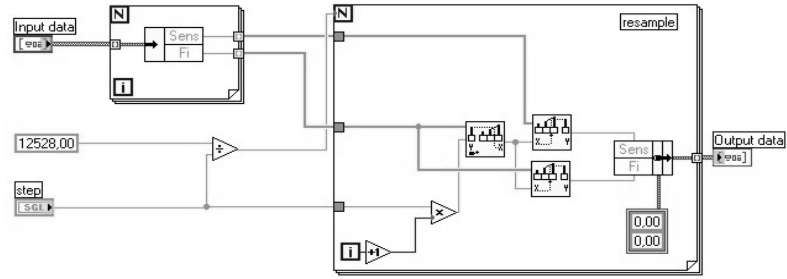

Fig. 6: *Preprocessing block*

3.3 DATA ANALYSIS

This part is used to analyze the previously acquired data and compute the grinding tool parameters. The acquired arrays have the form shown in Fig. 7.

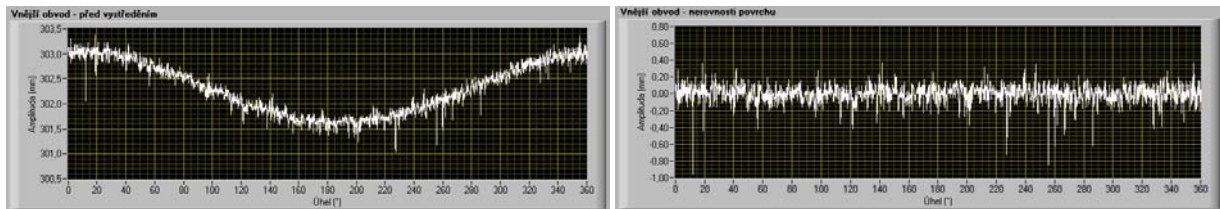

Fig. 7: *Preprocessed array before and after mathematical centering*

The characteristic sine shape is caused by the inaccurate centering of the tool and must be removed before the analysis starts. For this operation, the FFT algorithm is used to compute the first harmonic, which is then subtracted. This operation is called mathematical centering. Then another operation must be performed - finding the covering curve (envelope curve), which corresponds the real dimension of the grinding tool (It is desired to know the outer dimension.).

The covering curve is used to compute the shape deviations (e.g. circularity deviation) and its mean value represents the half of the diameter (D, H) or the whole height (T) of the grinding tool.

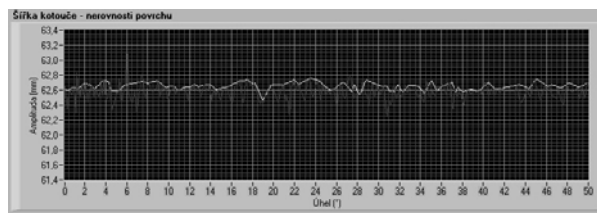

Fig. 8: *Array with covering curve*



Fig. 9: *Basic parameters computation scheme*

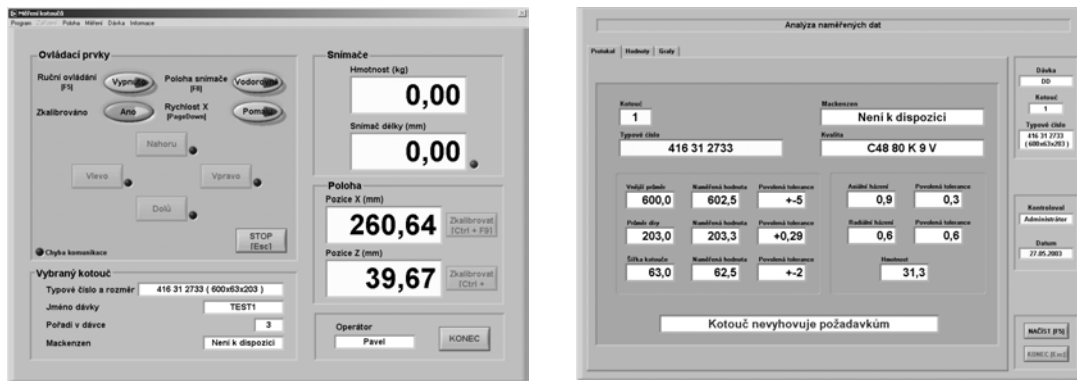

Fig. 10: Main window of the program and window with the results

3.4 USER INTERFACE

The user interface part contains all the dialogue, instruction and setup windows, e.g. sensor calibration, support position calibration, manual (not-automatic) support movement control etc. It also contains the windows for communication with databases.

3.5 AUTOMATIC MODE CONTROL

This part retakes control in the automatic modes. There are three (semi)automatic modes: grinding tools measurement, support recalibration and support parking (moving support to position safe for grinding tool manipulation). The operator simply chooses the mode and program retakes control of the process and instruct the operator what to do. Changing the orientation of the length sensor, rotation the turning base and measuring the weight of the grinding tool is not yet automated, so the operator must perform it manually. Further automation of these operations is possible and will be probably required.

4 CONCLUSION

The system with created software was successfully tested with several different grinding tools but it was not yet implemented into the manufacturing process. The system reaches the precision of 0.1 mm for basic dimensions and 200 g for weight. The precision of the secondary parameters of the grinding tool depends on the tool dimensions.

REFERENCES

- [1] National Instruments: LabVIEW: User Manual, 1998
- [2] Best - Business a.s.: GRINDING TOOLS II.- Vitrified bonded grinding tools for engineering industry, 1.1.2000
- [3] Hottinger Baldwin Messtechnik.: Měřicí zesilovač Spider8, 2000
- [4] ČSN ISO 4291, ČSN ISO 4292: Metody hodnocení úchylek kruhovitosti, Praha: Český normalizační institut, c 1994
- [5] ČSN 01 4420: Měření úchylek tvaru a polohy, Praha: Český normalizační institut, c 1982